

A large white industrial truck, possibly a tanker or transport vehicle, is shown from a side-rear perspective. The truck is partially obscured by a blue and red geometric overlay. The background is a bright, hazy outdoor setting, likely a parking lot or industrial area, with sunlight creating a lens flare effect on the right side.

# LEAKTIGHT SOLUTIONS FOR AUTOMOTIVE AND INDUSTRIAL VEHICLES



**T-CORE**  
— solutions



Production of sustainable tank solutions based on customer request or standard brand sizes. Our development process involves first idea to full-scale production in close collaboration with the client.

The standard fuel-, combined- and hydraulic oil tanks are made in 2,5 mm aluminium, both side's coated with polymer and certified by **ECE type approval E24**. Beside the standard aluminium various materials are available to fulfill specific customer requests.

We support the market for 30 years with Leaktight solutions for automotive and industrial vehicles. Please feel free to challenge us for detailed information or inquiries.

For more information see:





[www.t-coresolutions.nl](http://www.t-coresolutions.nl)

or contact:



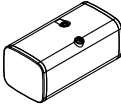
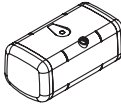
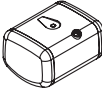

[info@t-coresolutions.nl](mailto:info@t-coresolutions.nl)

# FUEL TANKS

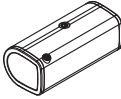

## Fuel tanks for **MERCEDES BENZ** (height x width)

560 x 640	565 x 650	565 x 735	700 x 650	700 x 700	700 x 735
					

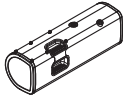
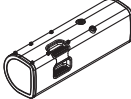

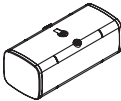
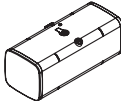

## Fuel tanks for **VOLVO** (height x width)

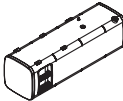
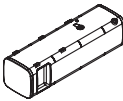
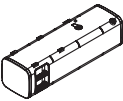
560 x 675	710 x 690	710 x 690	710 x 690	710 x 690	710 x 690
					

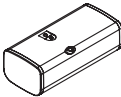

## Fuel tanks for **DAF** (height x width)

575 x 675	620 x 675	700 x 700	700 x 700	620 x 675	620 x 675
					

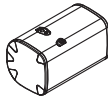

## Fuel tanks for **SCANIA** (height x width)

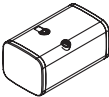
505 x 700	670 x 700	690 x 740	650 x 700	700 x 720
				

## Fuel tanks for **MAN** (height x width)

350 x 615	515 x 615	620 x 675	700 x 700
			

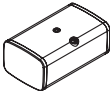
## Fuel tanks for **IVECO** (height x width)

480 x 670	625 x 680
	



## HYDRAULIC COMBINED TANKS

**Hydraulic 330 x 500**

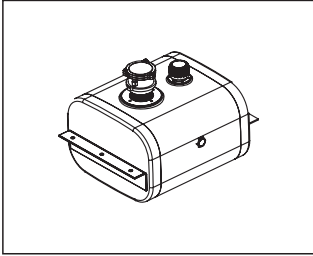

**Hydraulic 420 x 510**

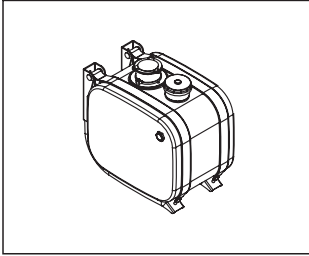

**Hydraulic 480 x 675**

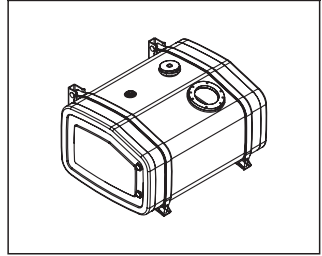

**Hydraulic 560 x 640**

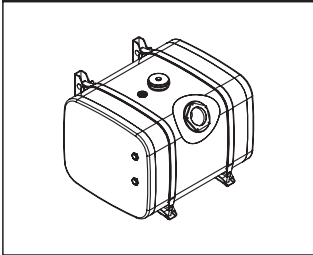

**Hydraulic 590 x 630**

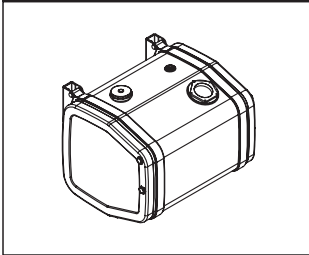

**Hydraulic 620 x 675**

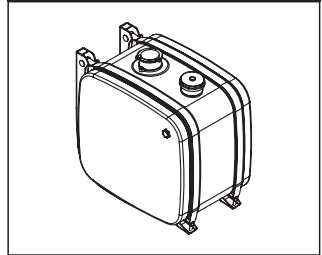

**Hydraulic 650 x 350**

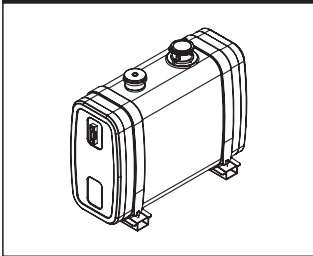

**Combined 620 x 675**

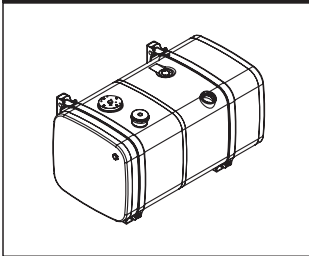

**Combined 700 x 700**

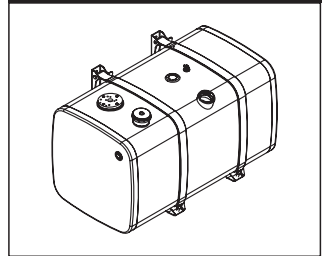

**Fuel, hydraulic, combined, universal tanks (height x width)**

All the dimensions above plus:

310x410	330x480	350x650	400x450	800x760	730x730
---------	---------	---------	---------	---------	---------



## MOUNTING BRACKETS/HOLDERS

**MAN / DAF / IVECO 620 x 675**

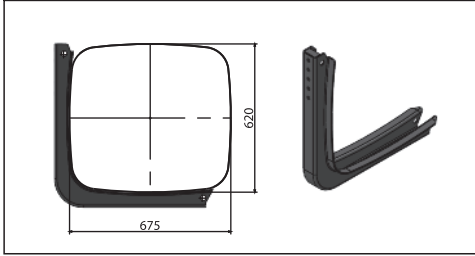

**SCANIA 505 x 700**

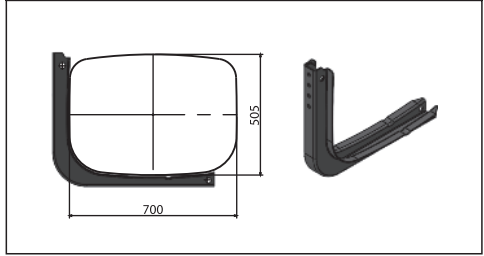

**Mercedes Benz / MAN / DAF 700 x 700**

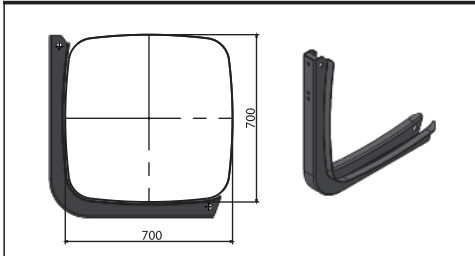

**SCANIA 670 x 700**

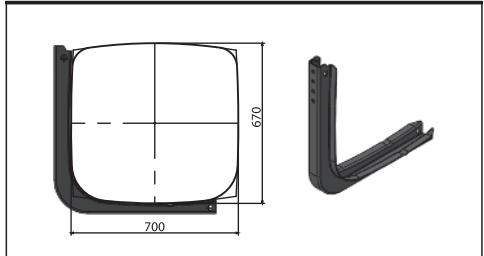

**Mercedes Benz MP4/5 650 x 700**

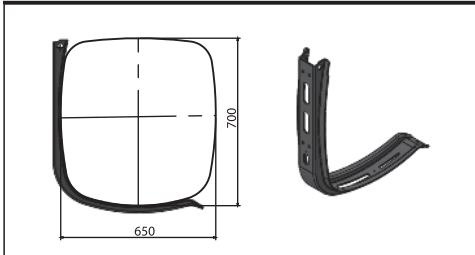

**SCANIA 740 x 690**

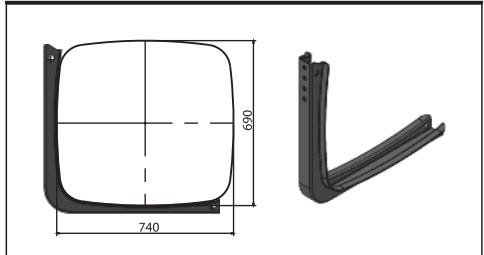

**Mercedes Benz MP4/5 737 x 700**

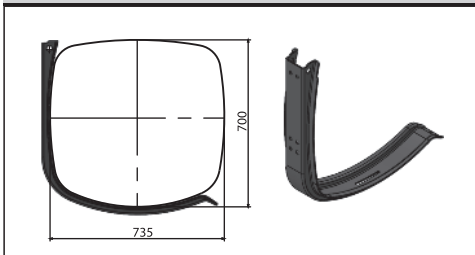

**Mercedes Benz 700 x 735 bracket back parts**

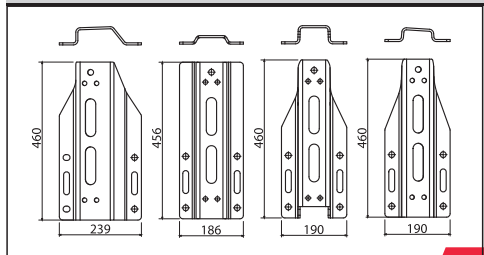

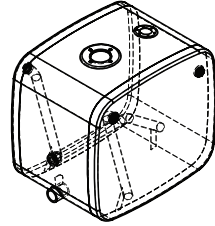
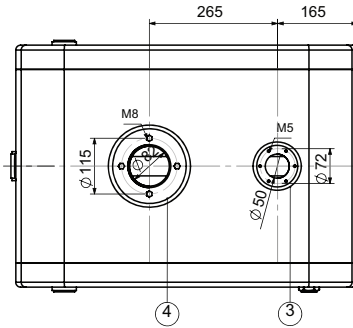
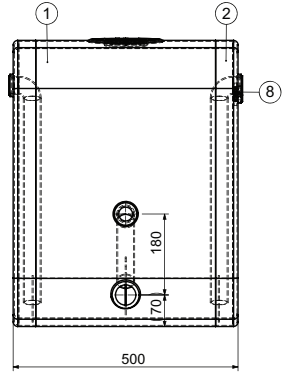
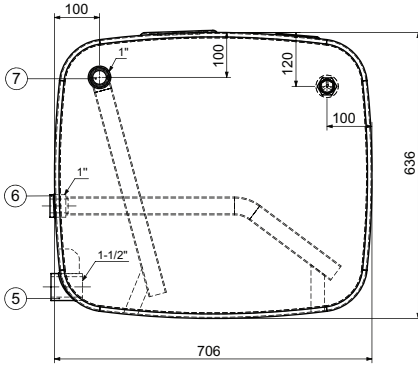

9-Alm. Cover

8-Level Indicator

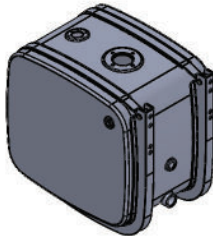

3-Filling Neck

Item	Qty	Part Name	Material
1	1	Body	Aluminum 5754-2.5mm
2	2	Side Plate	Aluminum 5754-2.5mm
3	1	Filling Neck	Aluminum 5754-2.5mm
4	1	Flange	Aluminum 5754-2.5mm
5	1	Suction Adater 1-1/2" BSP	Aluminum 6082
6	1	Suction Adater 1" BSP (Pipe 40mm)	Aluminum 6082
7	2	Return Adapter 1" BSP (Pipe 40mm)	Aluminum 6082
8	1	Level Indicator 1" BSP	Aluminum 5754-2.5mm
9	1	Aluminum Cover	Aluminum 5754-2.5mm
10	2	Bracket	Steel 5mm
11	2	Belt	Chromium

Drawing-A4	Signature	Product Name	Oil Tank	Liter	Material	Tolerance
Drafter	Murat Oktay	Dimensions	636X706X500mm	200	5754 Alm.	Weight
Approval		Product Code		Date	07.10.2025	
Scale	ECE R34	Explanation		Page	1	



**CUSTOMER SPECIAL 2**

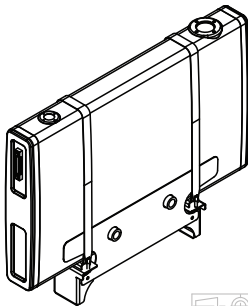
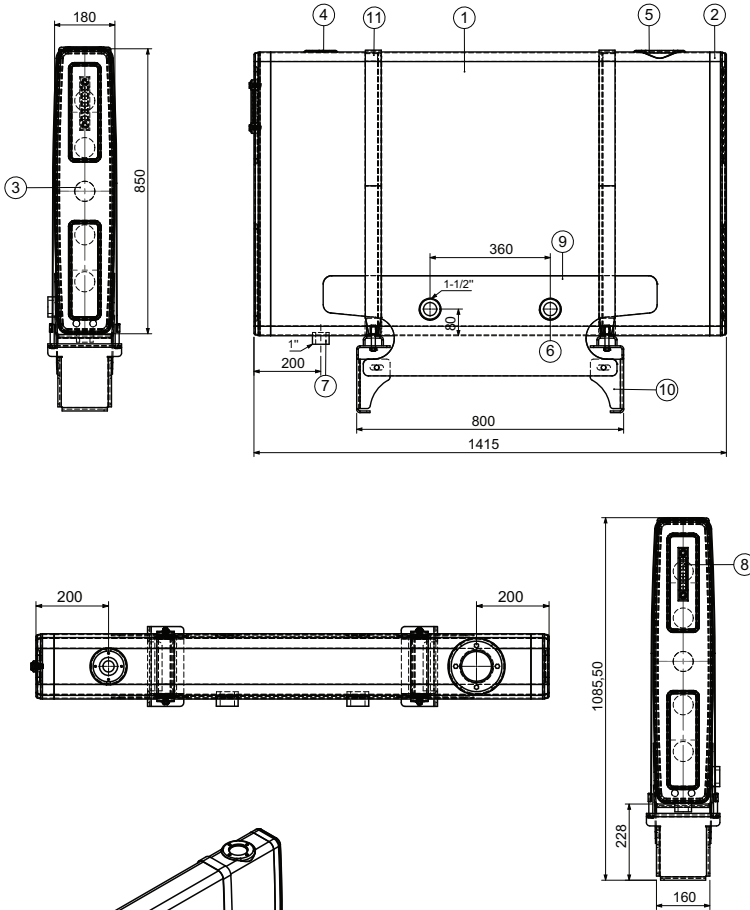

Item	Qty	Part Name	Material
1	1	Body	Alm. 5754-2,5mm
2	2	Side Plate	Alm. 5754-2,5mm
3	2	Baffle Plate	Alm. 5754-2,5mm
4	1	Filling Neck	
5	1	Flange	
6	1	Suction Adater 1-1/2" BSP	Aluminum 6082
7	1	Suction Adater 1" BSP	Aluminum 6082
8	1	Level Indicator 127mm	
9	1	Bracket Part	Steel 4mm
10	2	Bracket	Steel 4mm
11	2	Belt	Chromium 2mm

Signature	Product Name	Oil Tank	Liter	Material	Tolerance
Drawing-A4 Drafter: Murat Oktay	Oil Tank	Oil Tank	200	5754 Alm.	
Approval	Dimensions	180X850X1415MM			Weight
Scale	Product Code			Date	08.10.2025
	ECE R34	Explanation		Page	1



**T-Core Solutions B.V.**

Ericsonsstraat 2  
5121 ML Rijen  
The Netherlands

**Contact**

Rob Veenbergen Director

✉ [info@t-coresolutions.nl](mailto:info@t-coresolutions.nl)

🌐 [www.t-coresolutions.nl](http://www.t-coresolutions.nl)

☎ +31 6 531 527 65